

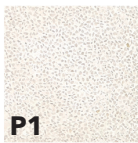

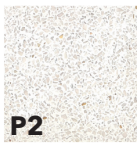

Dati tecnici
Lunghezza: 60 cm
Larghezza: 45 cm
Altezza: 28 cm
Spessore: 3,5 cm
Attacco piletta (al centro): 1" 1/4
Peso: 65 Kg
Ribassina: curva



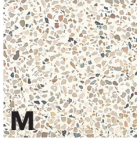
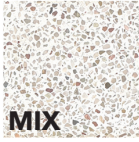
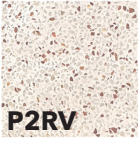
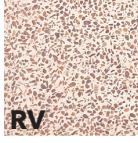
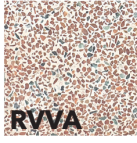
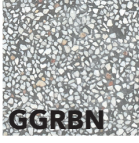
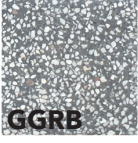
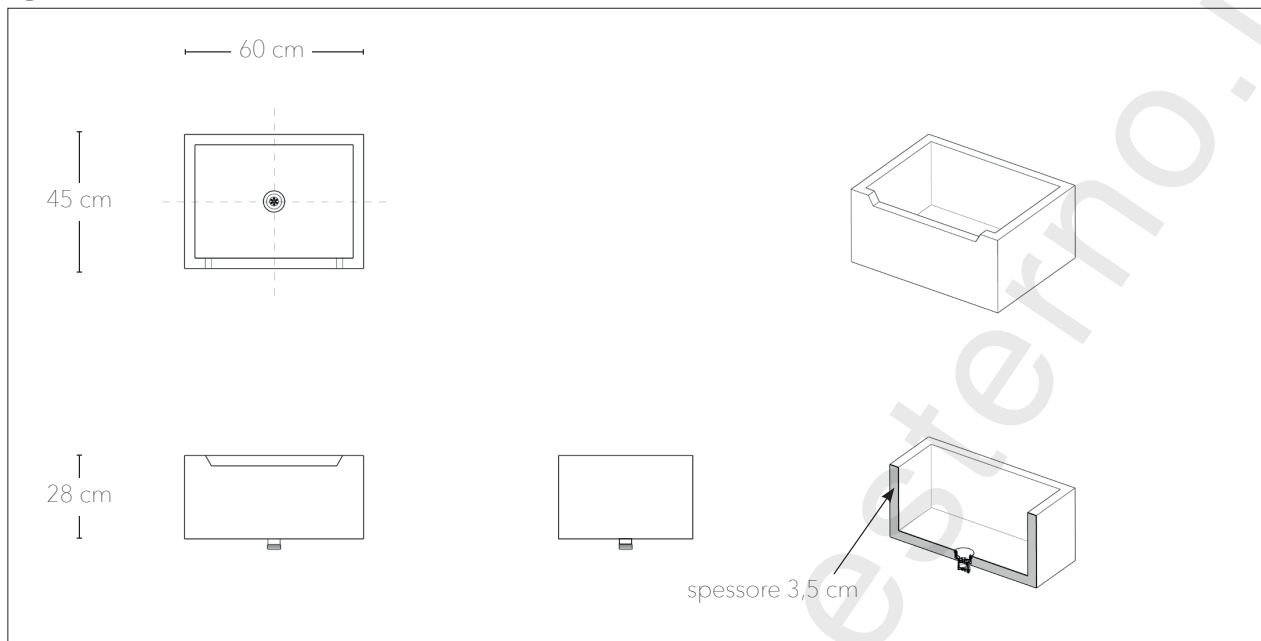

Contatti	
Mail	info@lavandinidaesterno.it
Sito	www.lavandinidaesterno.it
Telefono	06 22445605
Whatsapp	331 9986931
Indirizzo	Via di Pratolungo Casilino 2, 00132 - Roma

Finiture	
Cemento e graniglia di marmo levigato e trattato antimacchia	
Colorazioni possibili:	
P1_ Perlato n.1	
P2_ Perlato n.2	
P2GO_ Perlato n.2 giallo e oro	
P2GS_ Perlato n.2 giallo siena	
P2VA_ Perlato n.2 verde alpi	
M_ Multicolor	
MIX_ Colorato Mix	
P2RV_ Perlato n.2 rosso verona	
RV_ Rosso verona	
RVVA_ Rosso Verona e verde alpi	
GGRBN_ Fondo grigio e graniglia bianca	
GGRB_ Fondo grigio e graniglia bianca e nera	

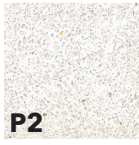
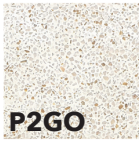
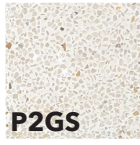

Dati tecnici
Lunghezza: 60 cm
Larghezza: 45 cm
Altezza: 28 cm
Spessore: 3,5 cm
Attacco piletta (al centro): 1" 1/4
Peso: 65 Kg
Ribassina: dritta

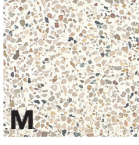
Contatti	
Mail	info@lavandinidaesterno.it
Sito	www.lavandinidaesterno.it
Telefono	06 22445605
Whatsapp	331 9986931
Indirizzo	Via di Pratolungo Casilino 2, 00132 - Roma

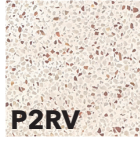
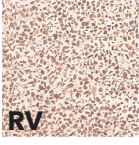
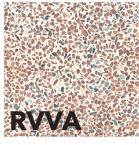
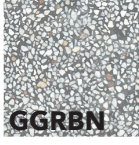
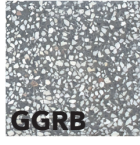
Finiture	
Cemento e graniglia di marmo levigato e trattato antimacchia	
Colorazioni possibili:	
P1_ Perlato n.1	
P2_ Perlato n.2	
P2GO_ Perlato n.2 giallo e oro	
P2GS_ Perlato n.2 giallo siena	
P2VA_ Perlato n.2 verde alpi	
M_ Multicolor	
MIX_ Colorato Mix	
P2RV_ Perlato n.2 rosso verona	
RV_ Rosso verona	
RVVA_ Rosso Verona e verde alpi	
GGRBN_ Fondo grigio e graniglia bianca	
GGRB_ Fondo grigio e graniglia bianca e nera	

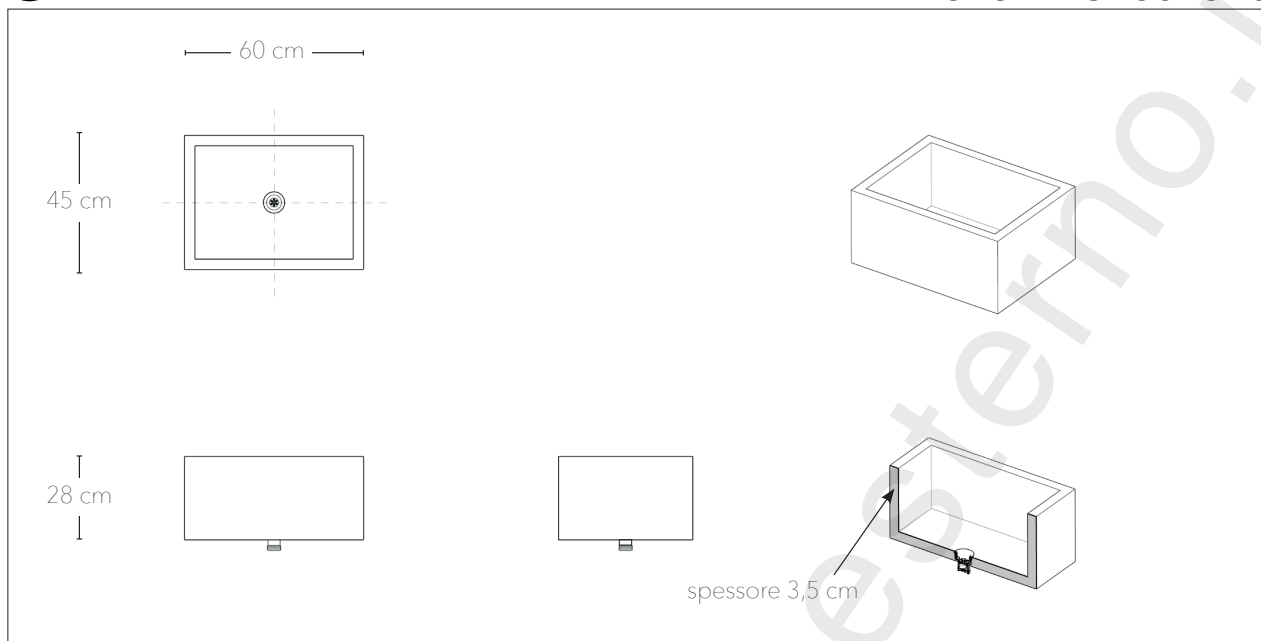

Dati tecnici
Lunghezza: 60 cm
Larghezza: 45 cm
Altezza: 28 cm
Spessore: 3,5 cm
Attacco piletta (al centro): 1" 1/4
Peso: 65 Kg
Ribassina: senza

Contatti	
Mail	info@lavandinidaesterno.it
Sito	www.lavandinidaesterno.it
Telefono	06 22445605
Whatsapp	331 9986931
Indirizzo	Via di Pratolungo Casilino 2, 00132 - Roma

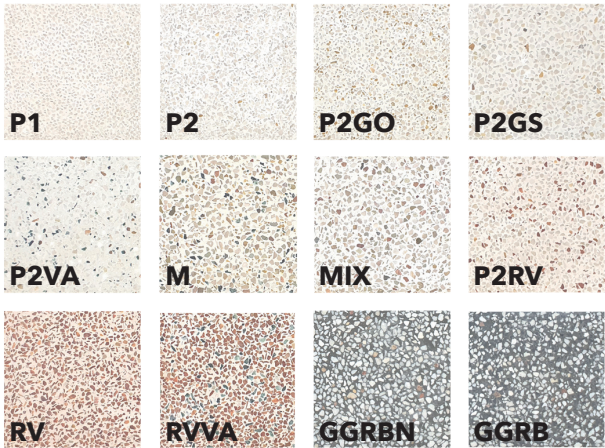
Finiture	
Cemento e graniglia di marmo levigato e trattato antimacchia	
Colorazioni possibili:	
P1_ Perlato n.1	
P2_ Perlato n.2	
P2GO_ Perlato n.2 giallo e oro	
P2GS_ Perlato n.2 giallo siena	
P2VA_ Perlato n.2 verde alpi	
M_ Multicolor	
MIX_ Colorato Mix	
P2RV_ Perlato n.2 rosso verona	
RV_ Rosso verona	
RVVA_ Rosso Verona e verde alpi	
GGRBN_ Fondo grigio e graniglia bianca	
GGRB_ Fondo grigio e graniglia bianca e nera	